



**MAXION / PERKINS
INTERNATIONAL**



70910572	MAXION / PERKINS / INTERNACIONAL NGD 30 POWERSTROKE	274
70910359	MAXION / PERKINS / INTERNACIONAL 3152	277
70910361	MAXION / PERKINS / INTERNACIONAL D3152	
70910831	MAXION / PERKINS / INTERNACIONAL 4203 INJEÇÃO DIRETA	280
70912931	MAXION / PERKINS / INTERNACIONAL 4203 DIRECT INJECTION	
70913001	MAXION / PERKINS / INTERNACIONAL 4203 INJEÇÃO DIRETA	283
70912981	MAXION / PERKINS / INTERNACIONAL D4236 / 4248	286
70913031	MAXION / PERKINS / INTERNACIONAL T4236 / 4248	
70910151	MAXION / PERKINS / INTERNACIONAL 4236 / Q20B (VEICULAR)	290
70914763	MAXION / PERKINS / INTERNACIONAL P10066 6T	293
70914053	MAXION / PERKINS / INTERNACIONAL P10044 4T	
70914753	MAXION / PERKINS / INTERNACIONAL 4000 / 4000T	296
70914733	MAXION / PERKINS / INTERNACIONAL S4 / S4T	299
70914773	MAXION / PERKINS / INTERNACIONAL HS2.5	302
70914873	MAXION / PERKINS / INTERNACIONAL HS2.8	
70913761	MAXION / PERKINS / INTERNACIONAL P6354.4	305
70913763	MAXION / PERKINS / INTERNACIONAL P6354.4	
70913813	MAXION / PERKINS / INTERNACIONAL P6354.4	
70912881	MAXION / PERKINS / INTERNACIONAL P6357	309
70913439	MAXION / PERKINS / INTERNACIONAL P6358	312

N°SET	DESCRIPTION		
70910572	FULL GASKET SET PERKINS NGD 30 POWER STROKE FORD RANGER / TROLLER W/OIL SEAL		1
70930572	HEAD GASKET SET NGD 30 POWER STROKE FORD RANGER / TROLLER W/O OIL SEAL		2
ABR N°	ORIGINAL N°	DESCRIPTION	
50951720	7X5,153X1,98	WASHER KIT	4 4
50984740	70490701	VALVE COVER GASKET	1 1
50980967	70490705	FRONT COVER GASKET	1
50985302	70490185	CYLINDER HEAD GASKET	1 1
50980440	70490709	OIL PAN TUBE GASKET	1
50980540	70490708	TIMING COVER GASKET	1
50980667	70490690	OIL COOLER GASKET	1
50981040	70490704	WATER PUMP GASKET	1 1
50981367	70490703	FRONT COVER SEAL	1
50981431	70490785	INTAKE EXHAUST MANIFOLD GASKET	4 4
50981531	3688C002	INTAKE MANIFOLD GASKET	4 4
50981867	70490692	WATER PUMP TUBE GASKET	1
50984940	70590020	WATER PUMP GASKET	1 1
50985740	70590021	INSPECTION COVER GASKET	1 1
50987340	70490814	FUEL PUMP GASKET	1
50992667		OIL RETURN TUBE GASKET	1
50992940	70490700	VALVE COVER SEAL GASKET	4 4
50997240	70490823	TIMING COVER GASKET	1
50997840	70490824	TIMING COVER GASKET	1
RE09101S		FRONT OIL SEAL	
RE05239F		REAR OIL SEAL	
RE09102F		VALVE STEM SEAL	16 16

APPLICATION



FORD RANGER 16V 2005/...

TROLLER T4 2006/...



50985302



50981431

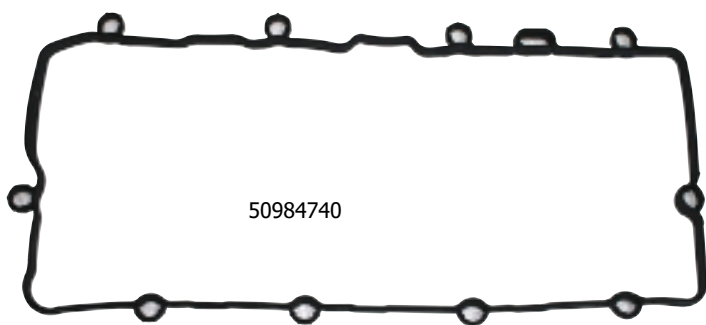

50984740



50981531



50992667



50951720



50981867



50992940

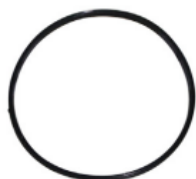

50984940



50981040

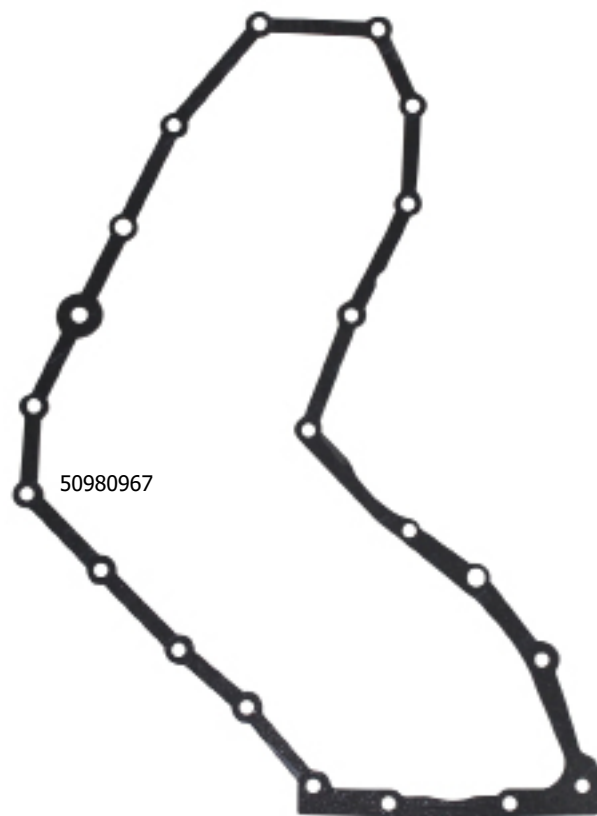

50980967



50981367

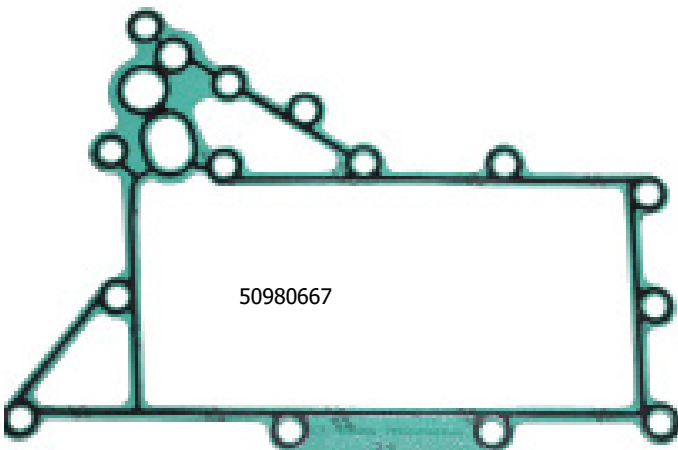
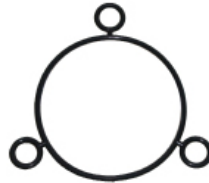
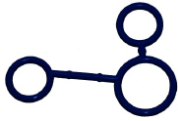
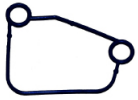
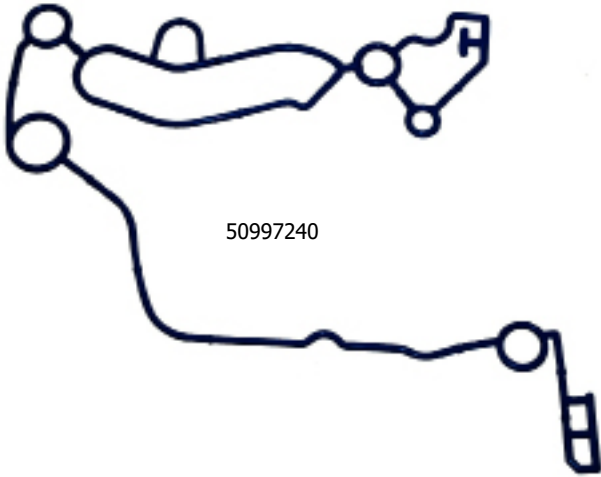

N°SET	DESCRIPTION
60910359	315202/315205 FULL GASKET SET PERKINS 3152 (INDIRECT INJECTION) W/O OIL SEAL
70910359	315202 FULL GASKET SET PERKINS 3152 (INDIRECT INJECTION) W/OIL SEAL
70930359	HEAD GASKET SET PERKINS 3152 (INDIRECT INJECTION) W/OIL SEAL
60910361	FULL GASKET SET PERKINS D3152 (DIRECT INJECTION) W/O OIL SEAL
70910361	FULL GASKET SET PERKINS D3152 (DIRECT INJECTION) W/OIL SEAL
60930361	HEAD GASKET SET PERKINS D3152 (DIRECT INJECTION) W/O OIL SEAL

ABR N°	ORIGINAL N°	DESCRIPTION	1	2	3	4	5	6
50900898	70490378	THERMOSTATIC GASKET	1	1	1	1	1	1
50907190	0490251	OIL PAN GASKET						1 1
50909016	70490353	EXSHAUT GASKET			2	2	2	
50909190	70490354	THERMOSTATS GASKET	1	1	1	1	1	1
50909290	70490354	WATER PUMP GASKET		1	1			1 1
50909390	70490355	REAR COVER GASKET CABEÇOTE	1	1	1	1	1	1
50909490	70490356	INLET WATER CONECTION GASKET		1	1			1 1
50909550	00490491	VALVE COVER GASKET						1 1 1
50911098	70490361	INTAKE MANIFOLD GASKET						1 1 1
50911298	70490357	OIL FILTER GASKET		1	1			1 1
50911509	70490822	CYLINDER HEAD GASKET						1 1 1
50912090	70490364	INSPECTION COVER GASKET		1	1			1 1
50912298	75490367	REAR COVER GASKET		1	1			1 1
50912990	70490313	OIL SEAL COVER GASKET						1 1
50913496	70490034	HIDRAULIC PUMP GASKET		1	1			1 1
50914198	70490381	FUEL PUMP GASKET						1 1
50914290	70490382	ACTUATOR TACHIMETER GASKET		1	1			1 1
50914396	70490343	INSPECTION COVER GASKET	1	1	1			1 1
50916098	70490063	DISTRIBUIÇÃO		1	1			1 1
50923816	70490014	OIL PUMP GASKET INJETORA	1	1	1	1	1	1 1
50926698	70490316	OUTLET EXHAUST GASKET		1	1			
50934616	70490373	FUEL PUMP GASKET	1	1	1			
50949316	70490737	OUTLET EXHAUST GASKET	2	2	2			
50949498	70490419	INTAKE EXHAUST MANIFOLD GASKET	1	1	1			
50949898	33826111	INTAKE MANIFOLD GASKET		1	1			
50950548		OIL FILTER COVER GASEKT						2 2
50953055	36811115	GASKET SET MANCAL	1	1	1			
50954898	70490321	VALVE COVER GASKET	1	1	1			
50971501	70490821	WATER PUMP GASKET	1	1	1			
80903226		CYLINDER HEAD GASKET						1 1 1
80903326		WASHER KIT	1	1	1			
80919350		WASHER KIT						1 1
80966190		OIL PAN GASKET SET		1	1			
RE00013S	70730016	OIL PAN GASKET SET		1				1
RE01972S		FRONT OIL SEAL		1				
RE00572S	30854	REAR OIL SEAL						1

APPLICATION



PERKINS P3152 INDIRECT INJECTION 3 CIL 2.4L
MASSEY FERGUSON TRACTOR MF 50X 1963/74 MF 55X 1974/...MF 235 1975/78 MF 250 1975/99 MF 350 1975/...
PERKINS P3152 DIRECT INJECTION 3 CIL 2.4L
MASSEY FERGUSON TRACTOR MF 235 1980/98

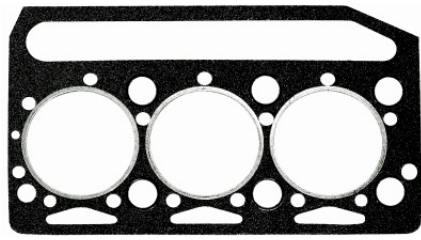

50911509

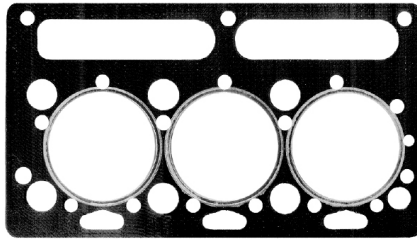

50971501

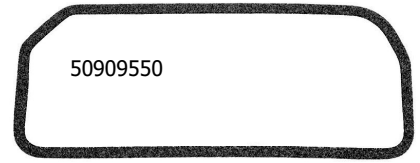

50909550



50949316



50909016

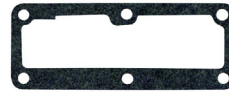

50911098

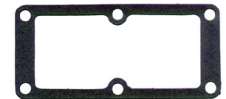

50909390

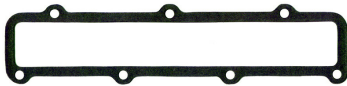

50949498

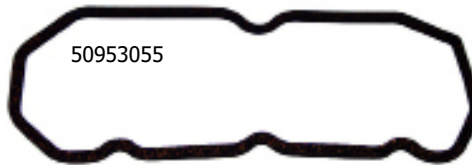

50953055

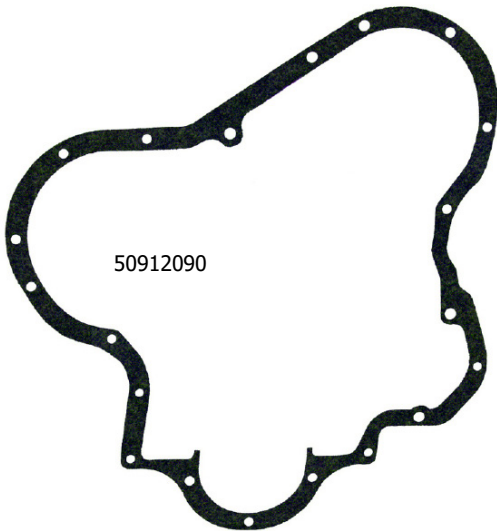

50912090



50934616



50923816

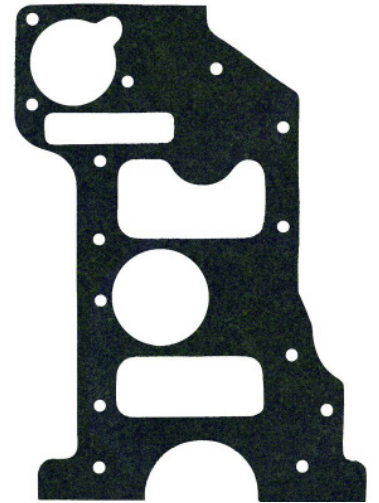

50912298



50914396

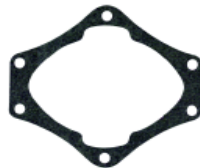

50912990

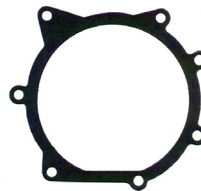

50954898



50909490

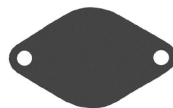

50913496



50909290



50909190



50914290



50916098



50900898

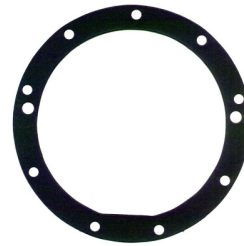
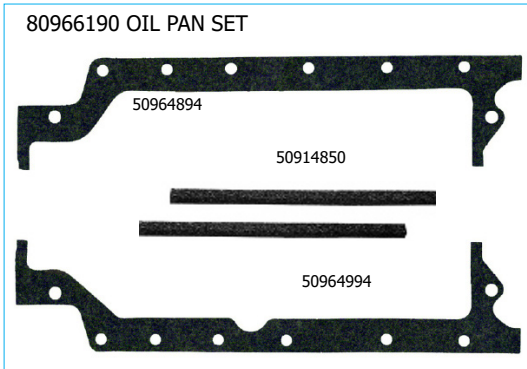

50949898

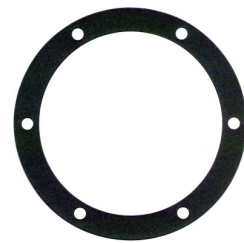
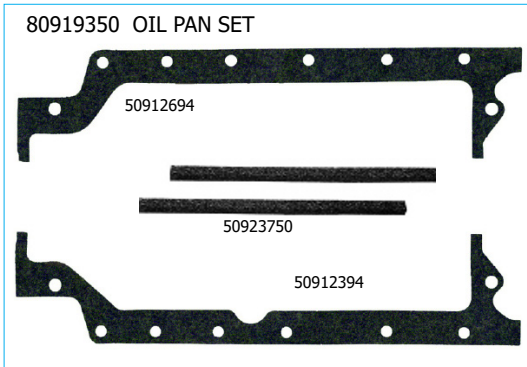

50907190



50926698



50914198



50911298



50950548



RE00013S



RE01972S



RE00572S

80903226		
Nº ABR	DESCRIPTION	Qty
50022224	WASHER KIT 14,0 x 20,8 x 1,5 mm	03
50035623	WASHER KIT CU 40,3 x 46,7 x 1,0	03
50906541	mm	06

80903326		
Nº ABR	DESCRIPTION	Qty
50937620	WASHER KIT 10,0 x 19,2 x 2,0 mm	03
50962240	Vedador Porta Injetor	03

N°SET	DESCRIPTION					
70910831	420302/420310	GASKET SET PERKINS 4203 (INDIRECT INJECTION) TRACTOR FORD 8BR W/OIL SEAL				1
70932931	420302	HEAD GASKET SET PERKINS 4203 (INDIRECT INJECTION) W/O OIL SEAL				2
60912931		GASKET SET PERKINS 4203 (INDIRECT INJECTION) TRACTOR MF 65/CBT 1000 W/O OIL SEAL				3
70912931	420302/420309	GASKET SET PERKINS 4203 (INDIRECT INJECTION) TRACTOR MF 65/CBT 1000 W/OIL SEAL				4

ABR N°	ORIGINAL N°	DESCRIPTION				
50906990	00490042	INTAKE MANIFOLD GASKET	1	1	1	1
50907016	70490818	INTAKE EXHAUST MANIFOLD GASKET	2	2	2	2
50909390	70490355	REAR COVER GASKET CABEÇOTE	1	1	1	1
50910198	0490692	INLET WATER CONECTION GASKET	1	1	1	1
50910250	70490401	CAM AXLE SEAL	1	1	1	1
50910390	70490359	OUTLET WATER CONECTION GASKET	1	1	1	1
50910450	00490704	VALVE COVER GASKET	1	1	1	1
50910590	0490706	WATER PUMP TUBE GASKET	1	1	1	1
50910698	0490707	FRONT CONNECTION GASKET	1	1	1	1
50910798	70490360	START MOTOR GASKET	1	1	1	1
50911298	70490357	OIL FILTER GASKET	1	1	1	1
50911398	70490724	INSPECTION COVER GASKET	1	1	1	1
50911601	70490411	TIMING COVER GASKET	1	1	1	1
50911898	70490310	CYLINDER HEAD GASKET				1
50912198	70490366	INSPECTION COVER GASKET				1
50912990	70490313	BOX DISTRIBUENTION GASKET	1	1	1	1
50913098	36817141	OIL SEAL COVER GASKET	1	1	1	1
50913394	36835412	OIL SEAL COVER GASKET	1	1	1	1
50913550	36846114	HIDRAULIC PUMP GASKET	1	1	1	1
50913650	36846409	INSPECTION COVER GASKET TUCHAS				1
50913850	36851107	REAR COVER OIL PAN GASKET	1	1	1	1
50914198	70430381	FRONT COVER GASKET	1	1	1	1
50914396	70490343	FUEL PUMP GASKET	1	1	1	1
50914490	36865108	INSPECTION COVER GASKET	1	1	1	1
50914590	36866414	TIMING COVER GASKET				1
50914698	70490342	TIMING COVER GASKET	1	1	1	1
50915290	70490391	FUEL COVER PUMP GASKET	1	1	1	1
50916098	70490063	WATER PUMP GASKET	1	1	1	1
50918098	70490011	INSPECTION COVER GASKET				1
50923290	36853105	OIL PUMP GASKET INJETORA				1
50923816		OIL PUMP GASKET	1	1	1	1
50923990	70490324	BETWEEN MANIFOLD GASKET	1	1	1	1
50933816	80490032	OUTLET EXHAUST GASKET	1	1	1	1
50950567	70730023	BOX DISTRIBUENTION GASKET	2	2	2	2
50959098	70490109	OUTLET EXHASUT GASKET				1
80903426		REAR MANCAL GASKET	1	1	1	1
80924550		BOX DISTRIBUENTION GASKET ADAP				1
80924694		EXAUST GASKET	1	1	1	1
RE00013N		KIT WASHER KITS	1	1	1	1
RE00572S	30554	OIL PAN GASKET	1	1	1	1

APPLICATION



PERKINS P4203 INDIRECT INJECTION 4 CIL 3.3L

FORD TRACTOR 8BR 1961/67

PERKINS P4203 INDIRECT INJECTION 4 CIL 3.3L

MASSEY FERGUSON TRACTOR MF 65 1965/82 CBT TRACTOR 1000 1975/...CASE TRACTOR 580E 1972/85

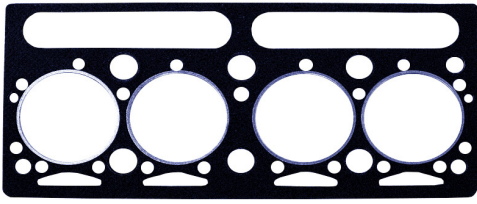

50911601



50910450



50906990



50933816



50923816



50907016



50913850



50913550



50915290

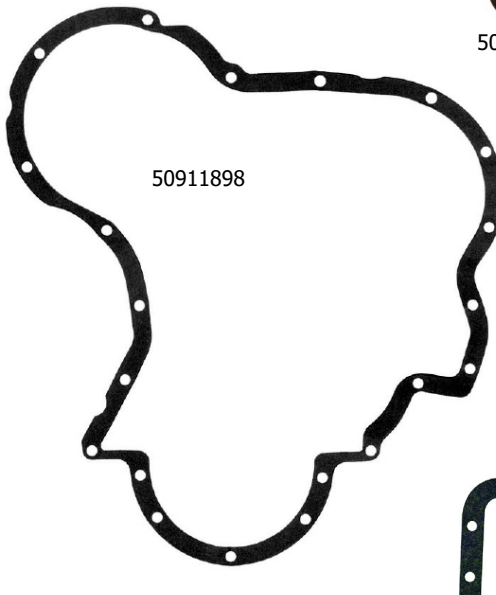

50911898



50910250



50914490



50914396

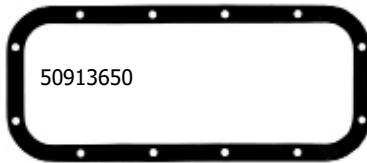

50913650

80924550 OIL PAN SET

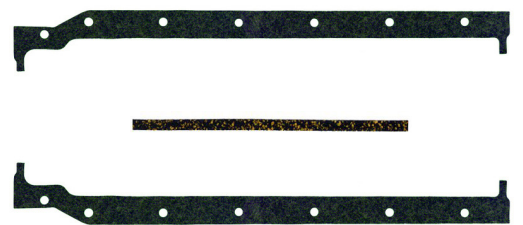

80924694 OIL PAN SET

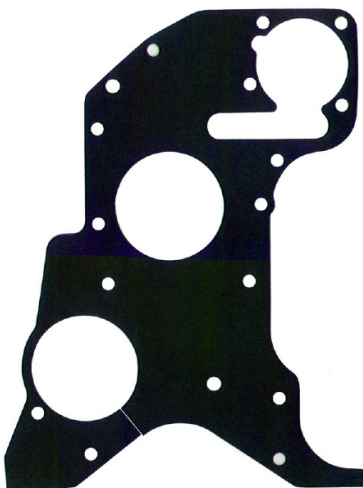
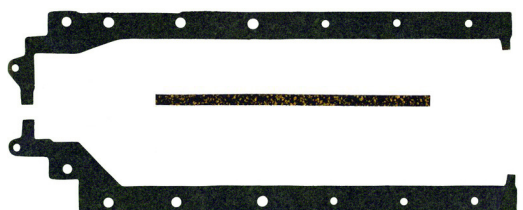

50912198



50923990

MAXION / PERKINS / INTERNATIONAL

MAXION / PERKINS / INTERNACIONAL 4203 DIRECT INJECTION



50913394

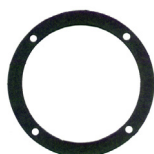

50911398



50918098



50910390



50910198



50923290

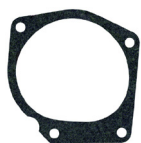

50914698



50914590



50911298



50910798



50914198



50959098



50909390

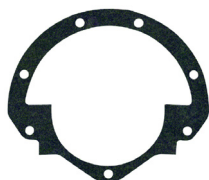

50913098



50910590

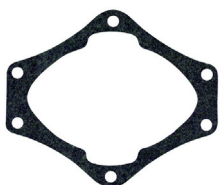

50912990



50910698



50916098



50950567



RE00572S



RE00013N

80903426		
Nº ABR	DESCRIPTION	Qty
50022224	WASHER KIT 14,0 x 20,8 x 1,5 mm	04
50036623	WASHER KIT CU 40,3 x 46,7 x 1,0	04
50906541	mm	08
50010341	Vedador Haste Válvula	01

N°SET	DESCRIPTION		
60913001	FULL GASKET SET PERKINS 4203 (DIRECT INJECTION) TRACTOR MF 65X / CBT 1000 / CASE 580E W/O OIL SEAL		1
70913001	FULL GASKET SET PERKINS 4203 (Inj direta) TRACTOR MF 65X/CBT 1000/CASE 580E W/OIL SEAL		2
70932791	HEAD GASKET SET PERKINS D4203 (DIRECT INJECTION) W/O OIL SEAL		3

ABR N°	ORIGINAL N°	DESCRIPTION			
50900316	70490344	INTAKE EXHAUST MANIFOLD GASKET	2	2	2
50900450	36811112	VALVE COVER GASKET	1	1	1
50909398	70490355	REAR COVER GASKET	1	1	1
50910198	70490692	INLET WATER CONECTION GASKET		1	1
50910390	70490359	OUTLET WATER CONECTION GASKET	1	1	1
50910590	70490706	INJECTION PUMP GASKET		1	1
50910698	70490707	FRONT CONNECTION GASKETSAÍDA ÁGUA	1	1	1
50910798	70490360	BY PASS CONECTION GASKET	1	1	1
50911298	70490357	OIL FILTER GASKET		1	1
50911701	70490742	CYLINDER HEAD GASKET	1	1	1
50910250	70490343	CAM AXLE SEAL		1	1
50914198	70490381	FUEL PUMP GASKET		1	1
50914396	70490343	INSPECTION COVER GASKET		1	1
50914490	36865108	TIMING COVER GASKET		1	1
50914698	70490342	WATER PUMP GASKET		1	1
50914798	70490388	INTAKE MANIFOLD GASKET	1	1	1
50915290	70490391	INSPECTION COVER GASKET		1	1
50916098	70490063	INJECTION PUMP GASKET		1	1
50923816	70490014	OUTLET EXHAUST GASKET	1	1	1
50923990	70490324	BOX DISTRIBUENTION GASKET		1	1
50933816	70490014	OUTLET EXHAUST GASKET	1	1	1
50950567	70730023	GASKET SET		2	2
50966140	2415745	LINER RING		1	1
80903690		WASHER BORRACHA KIT	1	1	1
80924694		OIL PAN GASKET		1	1
RE00013S	70730016	FRONT OIL SEAL		1	
RE00572S	30854	ACTUATOR TACHIMETER GASKET		1	

APPLICATION



PERKINS P4203 DIRECT INJECTION 4 CIL 3.3L
 MASSEY FERGUSON TRACTOR MF 265 1976/83 MF 65X 1972/80

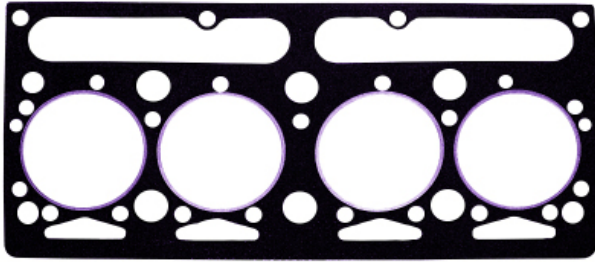

50911701



50900450



50914798



50923816



50933816



50900316



50910250

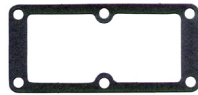

50909398

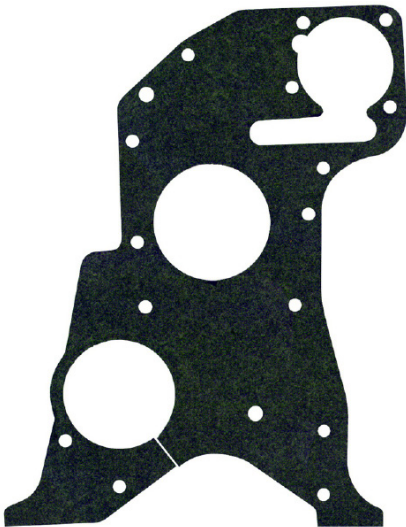

50923990



50914396



50915290



RE00572S



RE00013S



50950567

80924694 OIL PAN SET

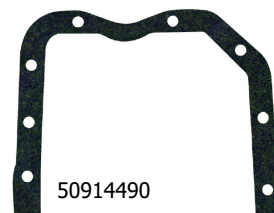
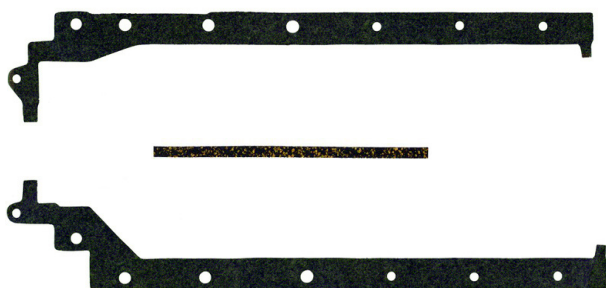

50914490

MAXION / PERKINS / INTERNACIONAL D4203 DIRECT INJECTION



50910390



50910198



50911298



50914698



50910798



50914198

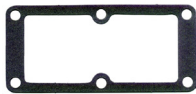

50909390

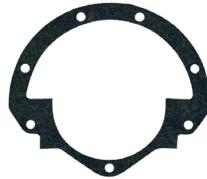

50913098



50910590

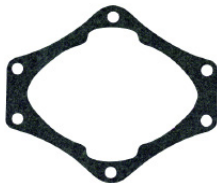

50912990



50910698



50916098

80903690		
Nº ABR	DESCRIPTION	Qtd
50937620	WASHER KIT 10,0 x 19,2 x 2,0 mm	04
50010341	Vedador 23,0 x 3,5 mm	01
50062240	Vedador Porta Injetor	04



50966140

MAXION / PERKINS / INTERNATIONAL

MAXION / PERKINS / INTERNACIONAL 4236 / 4248

N°SET	DESCRIPTION										
60912981	FULL GASKET SET PERKINS D4236 / 4248 AGRÍCOLA W/O OIL SEAL									1	
70912981	FULL GASKET SET PERKINS D4236 / 4248 AGRÍCOLA W/OIL SEAL									2	
70913031	FULL GASKET SET PERKINS T4236 TURBO TRACTOR MF292 W/OIL SEAL									3	
60913031	FULL GASKET SET PERKINS T4236 TURBO TRACTOR MF292 W/O OIL SEAL									4	
60916151	FULL GASKET SET PERKINS D4236 / 4248 CASE 580H W/O OIL SEAL									5	
70916151	FULL GASKET SET PERKINS D4236 / 4248 CASE 580H W/OIL SEAL									6	
70933031	HEAD GASKET SET PERKINS T4236 TURBO MF292 HASTE VÁLVULA W/OIL SEAL									7	
70930051	HEAD GASKET SET PERKINS D4236/4248 VEICULAR/AGRICOLA HASTE VÁL W/OIL SEAL									8	
ABR N°	ORIGINAL N°	DESCRIPTION									
RE02590F		VALVE STEM SEAL	8	8	8			8	8		
50050567	70730023	GASKET SET								2	2
50911498	70490402	ACTUATOR TACHIMETER GASKET			1	1	1	1	1	1	1
50913298	70490377	ACTUATOR TACHIMETER GASKET			1	1	1	1	1	1	1
50916098	70490063	INJECTION PUMP GASKET			1	1	1	1	1	1	1
50917996	70490800	INTAKE MANIFOLD GASKET TRAS	1		1	1				1	1
50918398	70490379	REAR COVER GASKET	1	1	1	1	1	1	1	1	1
50918655	70490149	VALVE COVER GASKETV	1	1	1	1	1	1	1	1	1
50918798	70490368	REAR COVER GASKET			1	1	1	1	1	1	1
50920898	36866722	OIL PUMP GASKET			1	1				1	1
50923498	70490385	BOX DISTRIBUTION GASKET			1	1	1	1	1	1	1
50924412	70490414	EXHAUST MANIFOLD GASKET	1	1	1	1	1	1	1	1	1
50924890	70490134	INSPECTION COVER GASKET							1	1	1
50925390	70490312	OIL PAN GASKET			1	1	1	1	1	1	1
50925590	36817136	BLOCK COVER GASKET			1	1				1	1
50925698	70490378	ACTUATOR TACHIMETER GASKET			1	1	1	1	1	1	1
50925790	70490408	THERMOSTATIC GASKET	1		1	1					1
50925890	70490796	INTAKE MANIFOLD GASKET FRONTAL	1		1	1				1	1
50925990	70490799	INTAKE MANIFOLD GASKET CENTRAL	1		1	1				1	1
50926016	36862134	INTAKE EXHAUST MANIFOLD GASKET	2		2	2				2	2
50926198	70490380	WATER CONECTION GASKET	1		1	1	1	1	1	1	1
50926298	70926298	COVER NOZZLE GASKET			1	1	1	1	1	1	1
50926498	70490383	OIL FILTER GASKET			1	1	1	1	1	1	1
50926598	70490341	WATER PUMP GASKET		1	1	1	1	1	1	1	1
50926698	70490316	FUEL PUMP GASKET			1	1	1	1	1	1	1
50930198	70490267	THERMOSTAT GASKET	1		1	1	1	1	1	1	1
50931757	36825107	WATER PUMP GASKET			1	1				1	1
50931998	70490412	INJECTION PUMP GASKET			1	1	1	1	1	1	1
50932090	70490100	RELIEF COVER GASKET			1	1					
50932598	70490386	REAR COVER GASKET			1	1					
50934198	70490347	OUTLET EXHAUST GASKET			1	1	1	1	1	1	1
50934616	70490373	INSPECTION COVER GASKET	2		2	2				2	2
50936998	70490365	EXHAUST ADAPTER GASKET			1	1					
50937398	70490145	INJECTION PUMP GASKET			1	1					
50942095	70490746	FUEL PUMP GASKET			1	1					
50942198	36856102	EXAUSTOR GASKET			1	1	1	1	1	1	1
50942270	70490267	INTAKE MANIFOLD GASKET FRONTAL			1	1					
50944430	3688C003	INTAKE MANIFOLD GASKET CENTAL		1					1	1	
50944630	3688C002	INTAKE MANIFOLD GASKET		1					1	1	
50944730	3688C001	TURBOCHARGING GASKET		1					1	1	
50945032	36885008	ENGINE BLOCK GASKET		1					1	1	
50946494	3687M006	INTAKE MANIFOLD GASKET							1	1	
50950098	70490398	OUTLET WATER CONECTIONGASKET							1	1	
50950398	70490345	TURBOCHARGING GASKET	1	1	1	1	1	1	1	1	1
50950890	70490314	TUBE SUCTION GASKET		1					1	1	
50951490	70490376	INTAKE EXHAUST							1	1	
50951630	3688C007	MANIFOLD GASKET		2					2	2	
50952790	70490317	TURBOCHARGING GASKET		1					1	1	
50954298	70490329	OIL FILTER GASKET			1	1	1	1	1	1	1
50955198	70490334	WATER CONECTION PUMP GASKET							1	1	
50965504	70490304	CYLINDER HEAD GASKET	1	1	1	1	1	1	1	1	1
80977940		WASHER KIT BRR	1	1	1	1	1	1	1	1	1
RE01050S		PULLEY OIL SEAL			1					1	1
RE01972S		REAR OIL SEAL			1					1	1

APPLICATION



PERKINS P4236 4 CIL 3.9L TURBO

MASSEY FERGUSON TRACTOR MF 292 1986/93

PERKINS P4236/P4248 4 CIL 4.1L

MASSEY FERGUSON TRACTOR MF 265 1984/00 MF275 1975/98 MF 272 1991/01 MF 290 1977/94

PERKINS P4236/P4248 4 CIL 4.1L

CASE TRACTOR 580H 1980/...

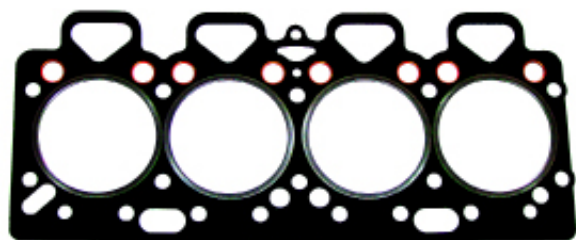

50965504

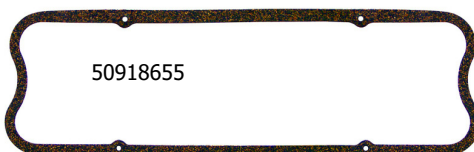

50918655



50944630



50926016

50951630



50934616



50944430



50917996

50944730



50925890



50925698



50925990



59331757



50925590



50924890

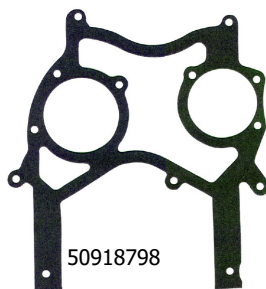

50918798



50936998



50937398



50926598



50950398



50931998



50955198

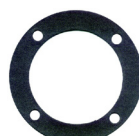

50911498



50932598



50926198



50950098



50922698



50922198



50945032



50952790



50950890

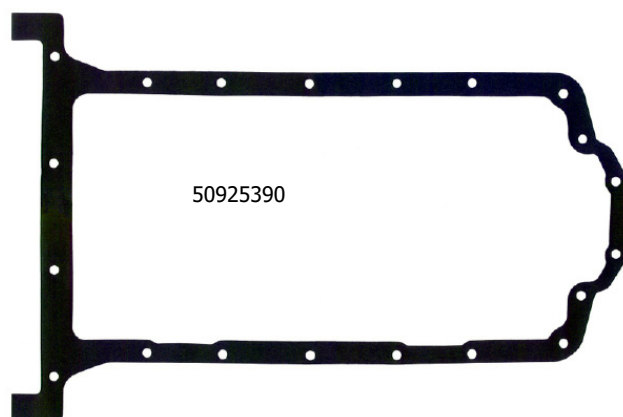

50925390



50954298



50926298



50942198



50913298



50926498



50916098



50926698



50951490

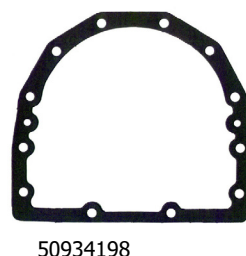

50934198



50920898



50942270



50923498



50942095



50930198



50932090



50931757

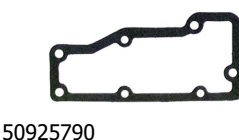

50925790

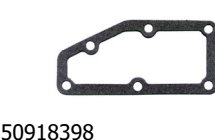

50918398



50946494



RE01972S



RE01050S



50050567

RE02590F



50924412

80977940			
N° ABR	N° Original	DESCRIPTION	Qty
50937620	70920081	WASHER KIT Bico Inj	04
50962240	70730019	10,0x19,2x2,0mm	04
50972641	32811408	Vedador Porta Injetor	02
50963941	33811113	Vedador Placa Intermediaria	01

N°SET	DESCRIPTION			
60910151	FULL GASKET SET PERKINS Q20B / 4236 D10/D20 W/O OIL SEAL			1
70910151	FULL GASKET SET PERKINS Q20B / 4236 D10/D20 W/OIL SEAL			2
60930051	FULL GASKET SET SUP PERKINS Q20B/D4236/4248 Veicular/Agricola W/O OIL SEAL			3
70930051	HEAD GASKET SET PERKINS Q20B/D4236/4248 Veicular/Agricola W/OIL SEAL			4

ABR N°	ORIGINAL N°	DESCRIPTION		
RE02590F		VALVE STEM SEAL	8	8
50917996	70490800	INTAKE MANIFOLD GASKET	1	1 1 1
50918398	70490379	REAR COVER GASKET	1	1 1 1
50918655	70490149	VALVE COVER GASKETV	1	1 1 1
50918798	70490368	REAR COVER GASKET		1 1
50922198	70490352	GASKET		1 1
50922398	70490370	OIL PAN GASKET		1 1
50922498	70490375	OIL FILTER GASKET		1 1
50922698	70490409	BLOCK COVER GASKET		1 1
50923398	70490407	INSPECTION COVER GASKET		1 1
50923498	70490385	BOX DISTRIBUTION GASKET		1 1
50924412	70490414	GASKET SET ESCAPAMENTO	1	1 1 1
50925698	70490378	ACTUATOR TACHIMETER GASKET		1 1
50925790	70490408	THERMOSTATIC GASKET	1	1 1 1
50925890	70490796	INTAKE MANIFOLD GASKET FRONTAL	1	1 1 1
50925990	70490799	INTAKE MANIFOLD GASKET CENTRAL	1	1 1 1
50926016	70490319	INTAKE EXHAUST MANIFOLD GASKET	2	2 2 2
50926198	70490380	OUTLET WATER CONECTION GASKET	1	1 1 1
50926498	70490383	OIL FILTER GASKET		1 1
50926698	70490316	FUEL PUMP GASKET		1 1
50930198	70490746	THERMOSTATIC GASKET	1	1 1 1
50931757	36825107	GASKET		1 1
50931998	70490412	WATER PUMP GASKET		1 1
50932090	70490100	INJECTION PUMP GASKET		1 1
50932598	70490328	RELIEF COVER GASKET		1 1
50934198	70490347	REAR COVER GASKET		1 1
50934616	70490373	OUTLET EXHAUST GASKET	2	2 2 2
50936898	70490328	INJECTION PUMP GASKET		1 1
50937398	70490145	EXHAUST ADAPTER GASKET		1 1
50942095	70490315	INJECTION PUMP GASKET		1 1
50942198	36856102	FUEL PUMP GASKET		1 1
50942270	70490267	EXAUSTOR GASKET		1 1
50949698	70490339	WATER PUMP GASKET		1 1
50949753	70490178	OIL PAN GASKET		1 1
50950098	70490398	INTAKE MANIFOLD GASKET		1 1
50950398	70490345	OUTLET WATER CONECTION GASKET	1	1 1 1
50965504	70490304	CYLINDER HEAD GASKET	1	1 1 1
80977940		WASHER KIT BORR	1	1 1 1
80979326		WASHER KIT		1 1
RE01050S		PULLEY OIL SEAL		1
RE01972S		REAR OIL SEAL		1

APPLICATION



PERKINS P4236/Q20B 4 CIL 3.9L
 VW TRUCK 6.80 1982/86 6.90P 1987/89
 AGRALE TRUCK 1800 D 1988/94
 CHRYSLER PICK-UP DODGE D400/P400 1976/81
 CHEVROLET PICK-UP D10 1979/84 D20 1985/92

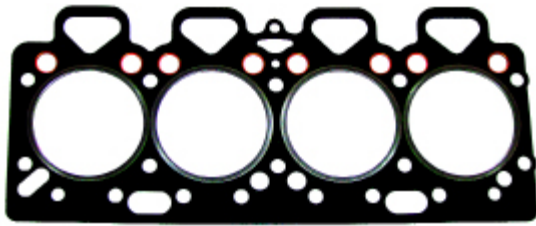

50965504



50918655



59331757



50926016



50934616



50925990



50925698



50917996



50925890



50925790

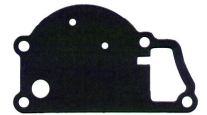

50931998



50923398



50918398

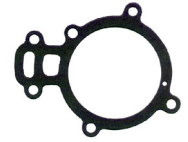

50937398



50950098



50932598

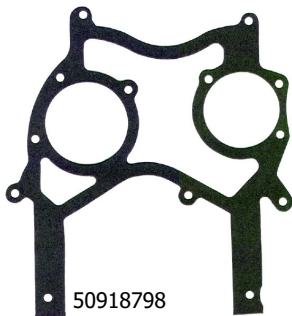

50918798



50922698



50926198



50924412



50922198

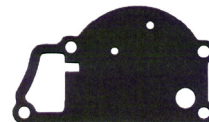

50949698



50950398



50949753



50922398



50922498



50926498



50942198



50936898



50926698

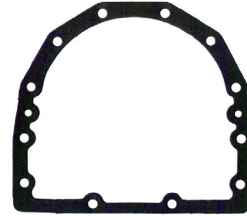

50934198



50942270

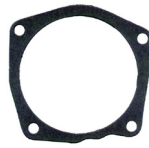

50923498



50942095



50930198



50932090



RE02590F



50931757



RE01050S



RE01972S

80979326		
Nº ABR	DESCRIPTION	Qty
50028725	WASHER KIT AL 8,0 x 12,0 x 1,0	01
50026929	mm	01
50023329	WASHER KIT AL 14,0 x 18,0 x 1,5	04
50020025	mm	07
50015529	WASHER KIT AL 16,0 x 22,0 x 1,5	14
50012929	mm	08
50009923	WASHER KIT AL 16,0 x 20,0 x 1,5	08

80977940			
Nº ABR	Nº Original	DESCRIPTION	Qty
50937620	70920081	WASHER KIT Bico Inj	04
50962240	70730019	10,0x19,2x2,0mm	04
50972641	32811408	Vedador Porta Injetor	02
50963941	33811113	Vedador Placa Intermediaria	01

N°SET	DESCRIPTION
60914763	GASKET SET PERKINS P10066/6T (MF 297/299/630/4050/605320/680) ASPIRADO/TURBO W/O OIL SEAL
70914763	GASKET SET PERKINS P10066/6T (MF 297/299/630/4050/605320/680) ASPIRADO/TURBO W/OIL SEAL
60934763	HEAD GASKET SET PERKINS P10066/6T (MF 297/299/630/4050/605320/680) ASPIRADO/TURBO W/O
60914053	GASKET SET PERKINS P10044/4T (MF 5300/5310) ASPIRADO/TURBO W/O OIL SEAL
70914053	GASKET SET PERKINS P10044/4T (MF 5300/5310) ASPIRADO/TURBO W/OIL SEAL
60934053	HEAD GASKET SET PERKINS P10044/4T (MF 5300/5310) ASPIRADO/TURBO W/O OIL SEAL

ABR N°	ORIGINAL N°	DESCRIPTION	1	2	3	4	5	6
50925390	368174007	OIL PAN GASKET	1	1				
50932831	736882191	INTAKE EXHAUST MANIFOLD GASKET	2	2	2	2	2	2
50937620	70920081	WASHER GASKET	4	4	4	6	6	6
50938030	70490160	INTAKE MANIFOLD GASKET CENTRAL	2	2	2	2	2	2
50939300	3681E037	CYLINDER HEAD GASKET	1	1	1			
50942941		VALVE STEM SEAL	8	8	8	12	12	12
50944532	36866746	INTAKE EXHAUST MANIFOLD GASKET	1	1	1	1	1	1
50945032	36885008	TURBO GASKET	1	1	1	1	1	1
50945431	70490161	INTAKE MANIFOLD GASKET	2	2	2	2	2	2
50947090	3681P009	BOX DISTRIBUTION GASKET	1	1		1	1	
50948067	3681P011	INSPECTION COVER GASKET	1	1		1	1	
50949540	70490258	VALVE COVER GASKET	1	1	1			
50967840	70920081	INJECTION PUMP GASKET	4	4	4	6	6	6
50970150	3681C001	VALVE COVER GASKET				1	1	1
50970290	3382P004	WATER PUMP GASKET	1	1			1	1
50971190	3681H007	OIL PAN GASKET						1
50971400	3681H218	CYLINDER HEAD GASKET					1	1
50981967	3685N008	EXHAUST TUBE GASKET	1	1	1	1	1	1
50982067	3685R005	THERMOSTATIC GASKET	1	1	1	1	1	1
50982167	3685F006	THERMOSTATIC GASKET	1	1	1	1	1	1
50982267	3683H006	TURBOCHARGING GASKET	1	1	1	1	1	1
50982367	36832135	INLET OIL PUMP GASKET	1	1	1	1	1	1
50982467	36832131	OUTLET OIL PUMP GASKET	1	1	1	1	1	1
50982567	3686A004	THERMOSTATIC GASKET	1	1	1	1	1	1
50982667	3684R004	OIL FILTER GASKET	1	1			1	1
50982767	3687W003	OIL FILTER GASKET	1	1			1	1
50982867	3687Y002	OIL FILTER GASKET	1	1			1	1
50982967		POWER SUPPLY GASKET	1	1			1	1
50983067	3687H005	OIL SEAL COVER GASKET	1	1			1	1
50983167	36817181	INSPECTION COVER GASKET	1	1			1	1
50983267	3682H003	OIL FILTER GASKET	1	1			1	1
50983367	368A511	FUEL PUMP GASKET	1	1			1	1
50983467	33828108	INJECTION PUMP GASKET	1	1			1	1
50983567	3686T004/006	OIL FILTER GASKET	1	1			1	1
50983667		TUBE GASKET	1	1			1	1
50983767	36811115	OIL FILTER BREATHER GASKET	1	1			1	1
50983867		THERMOSTATIC GASKET	1	1			1	1
50983967	3683N004	THERMOSTATIC GASKET	1	1			1	1
50984067		THERMOSTATIC GASKET	1	1			1	1
50984167	36832143	OIL PUMP GASKET	1	1			1	1
RE01050S		PULLEY OIL SEAL	1					1
RE01972S		REAR OIL SEAL	1					1

APPLICATION



PERKINS P1004/P1004.4 4 CIL 4.0L ASP/TURBO
M.FERGUSON TRACTOR MF 610/620 1992/99 MF 5300 1999/10
PERKINS P1006/P1006-6T 6 CIL 6.0L ASP/TURBO
M.FERGUSON TRACTOR MF 297 1993/09 MF 299 1993/07 MF 630/640 1993/99 MF 650/660 1993/07
MF 680 1993/08 MF 5320 1999/10 MASSEY FERGUSON COLHEITADEIRA MF 6855 1992/04



50939300

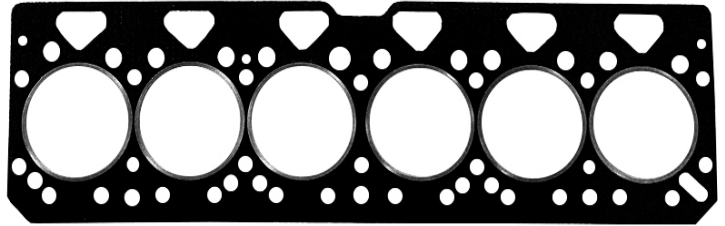

50971400

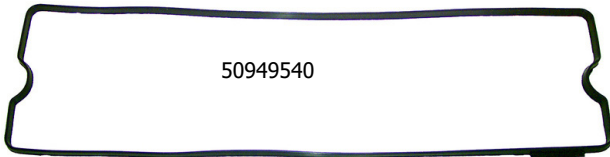

50949540

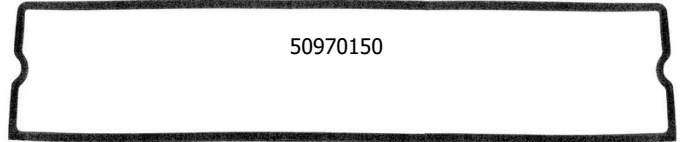

50970150

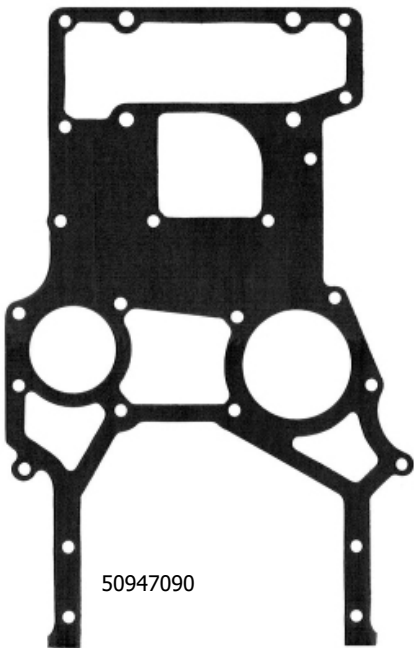

50947090



50938030



50944532



50981967



50932831



50945431



50983967



50983067



50982967

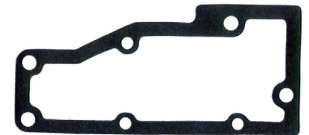

50982167

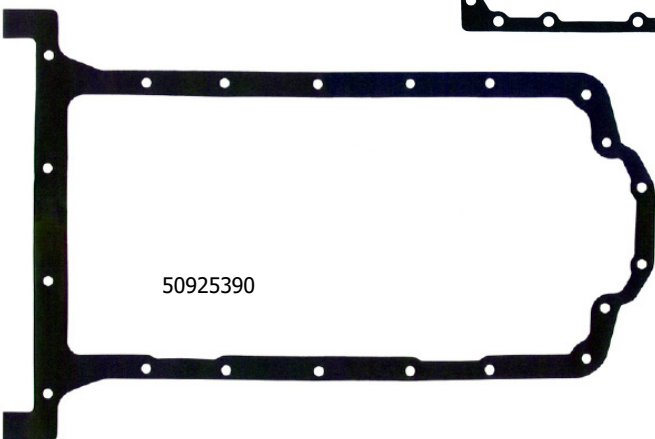

50925390



50982067

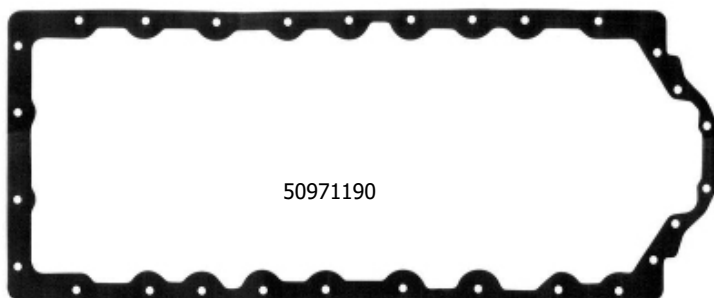

50971190

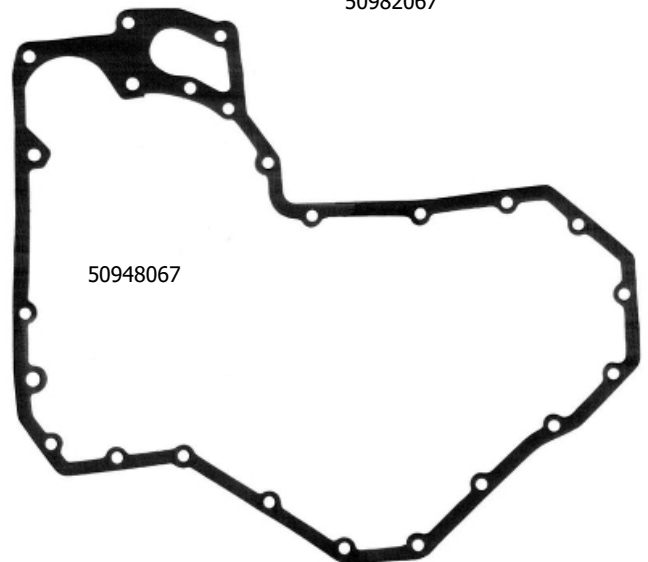

50948067



50982667

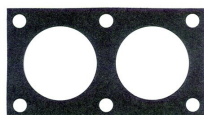

50982567



50945032

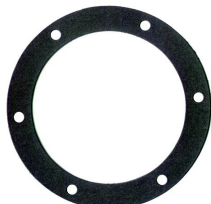

50970290



50936898



50983167



50982267



50983667



50983267



50984067



50982467



50982867



50982767



50982367



50984167



50983367



50983867



50983767



50982867



50967840



50942941



50937620

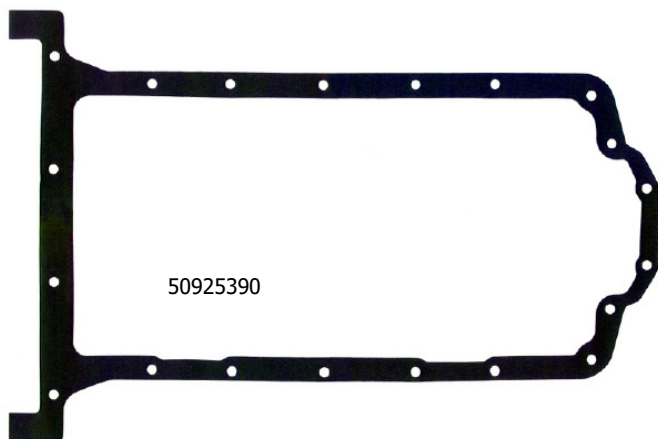

50925390

MAXION / PERKINS / INTERNATIONAL

MAXION / PERKINS / INTERNACIONAL P4000/P4000T

N°SET	DESCRIPTION	
60914753	FULL GASKET SET PERKINS P4000/4000T (MF 275/283/290/292/610/620/5275/85/90) ASPIRADO/TURBO W/O OIL SEAL	1
70914753	FULL GASKET SET PERKINS P4000/4000T (MF 275/283/290/292/610/620/5275/85/90) ASPIRADO/TURBO W/OIL SEAL	2
70934751	HEAD GASKET SET P4000/4000T (MF 275/283/290/292/610/620/5275/85/90) ASPIRADO/TURBO W/OIL SEAL	3

ABR N°	ORIGINAL N°	DESCRIPTION		
RE02590F		VALVE STEM SEAL	8	8
50913298	70490377	TUBE SUCTION GASKET BOMBA	1	1
50917996	70490800	INTAKE MANIFOLD GASKET	1	1
50924890	70490311	INSPECTION COVER GASKET	1	1
50925390	3681H007	OIL PAN GASKET	1	1
50925698	70490378	GASKET	1	1
50925790	70490408	THERMOSTATIC GASKET	1	1
50925890	70490796	INTAKE MANIFOLD GASKET FRONTAL	1	1
50925990	70490799	INTAKE MANIFOLD GASKET CENTRAL	1	1
50926198	70460380	OUTLET WATER BRETHHER CURVE GASKET	1	1
50926298	70490320	FUEL PUMP NOZZLE GASKET	1	1
50926498	70490383	OIL FILTER GASKET	1	1
50926598	70490341	WATER PUMP GASKET	1	1
50931757	36825107	ACTUATOR TACHIMETER GASKET	1	1
50931996	70490412	WATER PUMP GASKET	1	1
50934198	70490347	REAR COVER GASKET	1	1
50936898	70490328	INJECTION PUMP GASKET	1	1
50942198	36856102	FUEL PUMP GASKET	1	1
50945032	36885008	TURBOCHARGING GASKET	1	1
50946494	3687M006	ENGINE BLOCK GASKET	1	1
50948890	70490713	INLET OIL PUMP GASKET TURBINA	1	1
50949090	70490369	BOX DISTRIBUTION GASKET	1	1
50949540	70490258	VALVE COVER GASKET	1	1
50950398	70490345	THERMOSTATIC VALVE GASKET	1	1
50950890	70490314	OUTLET TURBOCHARGING GASKET	1	1
50951490	70490376	FUEL PUMP TUBE GASKET	1	1
50951630	3688C007	INTAKE EXHAUST MANIFOLD GASKET	2	2
50953304	70490415	CYLINDER HEAD GASKET	1	1
50954298	70490375	TUBE SUCTION GASKET ÓLEO	1	1
50955198	70490334	WATER PUMP GASKET	1	1
50971017	70490283	TURBOCHARGING GASKET	1	1
50918398	70490379	REAR COVER GASKET CABEÇOTE	1	1
60014756		WASHER KIT BRR	1	1
RE01050S		PULLEY OIL SEAL	1	1
RE01972S		REAR OIL SEAL	1	1

APPLICATION

PERKINS P4000 4 CIL 4.1L ASP/TURBO

M.FERGUSON TRACTOR MF 265 2002/10 ; MF 275 1998/10 ; MF 283 1998/02 ; MF 290 1994/10 ; MF 292 1992/09 ;

MF 5275/5285/5290/5310 1999/10

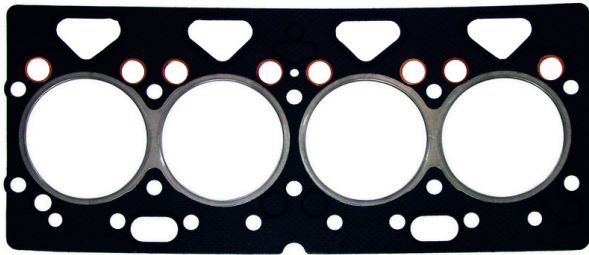

50953304

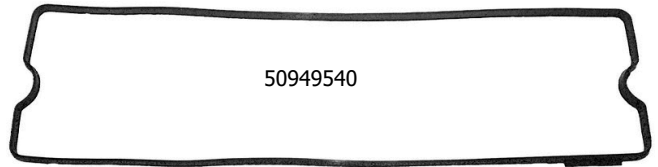

50949540



50951630



50925990



50917996



50918398

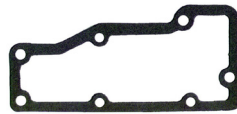

50925790

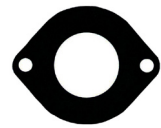

50950398



50925698



50946494

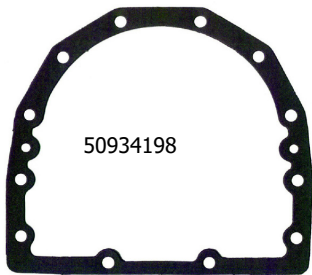

50934198



50949090



50924890

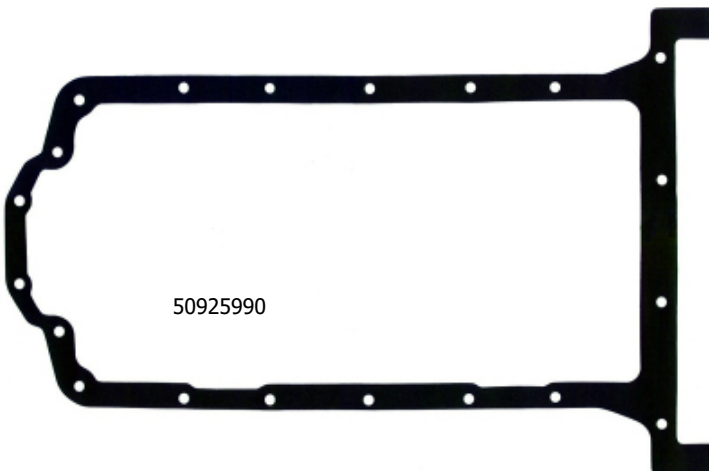

50925990



50945032



50971017



50950890



50948890



50926598



50936898



50926498



50955198



50931996



50942198



50926198

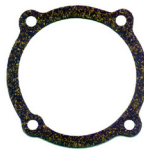

50931757



50913298



50951490



50954298



50926298



RE01972S



RE01050S



RE02590F

60014756		
Nº ABR	DESCRIPTION	Qtd
50012325	WASHER KIT AL 8,3 x 15,0 x 2,0	04
50016529	mm	05
50937620	WASHER KIT CU 10,0 x 14,0 x 1,5	02
50010123	mm	09
50917220	WASHER KIT CU 10,0 x 19,2 x 2,0	04
50963941	mm	01

N°SET	DESCRIPTION		
60914733	FULL GASKET SET PERKINS S4/S4T / D20 / D40 W/O OIL SEAL		1
70914733	FULL GASKET SET PERKINS S4/S4T D20 / D40 W/OIL SEAL		2
70934731	HEAD GASKET SET PERKINS S4/S4T D20/D40 W/OIL SEAL HASTE VÁLVULAS W/OIL SEAL		3

ABR N°	ORIGINAL N°	DESCRIPTION			
RE02590F		VALVE STEM SEAL	8	8	
50918398	70490379	REAR COVER GASKET CABEÇOTE	1	1	1
50923498	70490385	VACCUM PAMP GASKET		1	1
50925790	70490408	THERMOSTATIC GASKET	1	1	1
50934198	70490347	REAR COVER GASKET		1	1
50936898	70490328	INJECTION PUMP GASKET		1	1
50942095	70490315	INJECTION PUMP GASKET		1	1
50942198	36856102	INTAKE MANIFOLD CURVE GASKET		1	1
50943298	70490257	OIL FILTER GASKET	1	1	1
50943398	70490335	BETWEEN MANIFOLD GASKET DISTRIBUIÇÃO		1	1
50943598	70490413	INTAKE MANIFOLD GASKET		1	1
50944430	3688C003	INTAKE MANIFOLD GASKET	1	1	1
50944630	3688C002	REAR INTAKE MANIFOLD GASKET	1	1	1
50944730	3688C001	TURBOCHARGING GASKET	1	1	1
50945032	36885008	THERMOSTATIC GASKET	1	1	1
50946398	70490337	TURBOCHARGING GASKET	1	1	1
50948890	70490713	WATER PUMP GASKET	1	1	1
50948998	70490336	BOX DISTRIBUENTION GASKET		1	1
50949090	7049090*	VALVE COVER GASKET		1	1
50949540	70490358	WATER PUMP GASKET	1	1	1
50949698	70490339	OIL PAN GASKET		1	1
50949753	70490178	INTAKE MANIFOLD GASKET		1	1
50950098	70490398	OUTLET OIL CRANKSHAFT GASKET		1	1
50950890	70490314	INTAKE EXHAUST MANIFOLD GASKET	1	1	1
50951630	3688C007	CYLINDER HEAD GASKET	2	2	2
50951832	3688A009	RUBBER KIT	1	1	1
50953304	70490415	WASHER KIT	1	1	1
80964541		PULLEY OIL SEAL	1	1	1
80978020		REAR OIL SEAL		1	1
RE01050S		FRONT CRANKSHAFT OIL SEAL		1	
RE01972S		REAR CRANKSHAFT OIL SEAL		1	

APPLICATION



PERKINS S4/S4T 4 CIL 4.1L ASP/TURBO

CHEVROLET TRUCK GMC 6100 1997/...PICK-UP D20/D40 1992/97

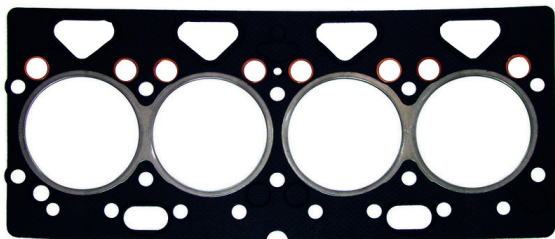

50953304

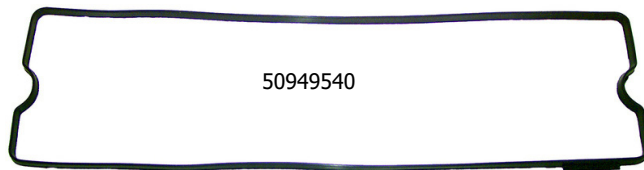

50949540



50951630



50944630



50944730



50944430

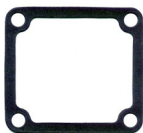

50943298



50918398 189



50925790



50945032

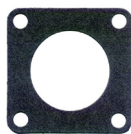

50946398

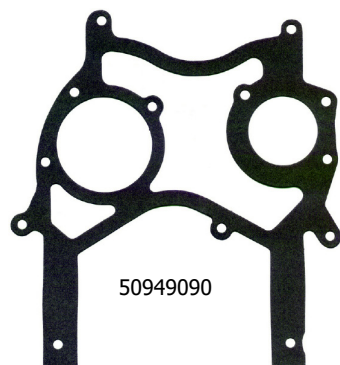

50949090



50951832

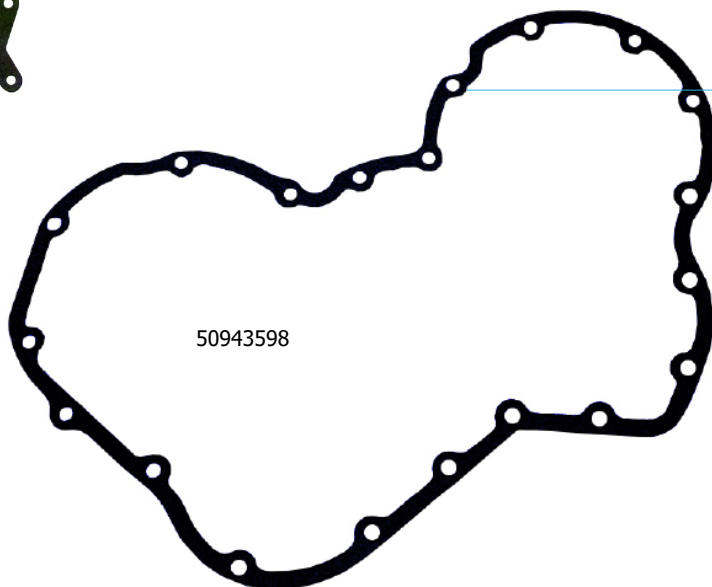

50943598



50949753



50936898



50942095



50923498

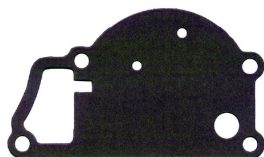

50949698



50948998



50942198



50950890/



50948890



50950098

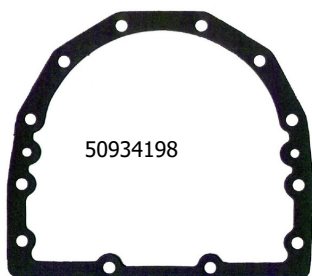

50934198



50943398



RE01972S



RE01050S



RE02590F

80964541			
Nº ABR	Nº Original	DESCRIPTION	Qty
50964141	70590007	Anel Borracha Câter	02
50964041	33817132	Vedador Porta Injetor	04
50964241	70590008	Vedador Bico Injetor	04
50963941	33811113	Anel Tubo Lubrificante Cabeçote	01
50964341	70590009	Vedador Tampa Caixa Distribuição	01
50964441	70590011	Vedador Tampa Cabeçote	01

80978020			
Nº ABR	DESCRIPTION	Qty	
50009923	WASHER KIT CU 6,2 x 10,2 x 1,0	06	
50011228	mm	02	
	WASHER KIT AL 8,0 x 12,0 x 1,0	04	
50021129	mm	08	
50023329	WASHER KIT CU 8,0 x 12,0 x 2,0	03	
50023629	mm	04	
50015529	WASHER KIT AL 14,0 x 18,0 x 1,5	04	
50028725	mm	02	
50011024	WASHER KIT AL 16,0 x 22,0 x 1,5	04	

MAXION / PERKINS / INTERNATIONAL

MAXION / PERKINS / INTERNACIONAL HS2.5 / HS2.8

N°SET	DESCRIPTION
60914773	FULL GASKET SET PERKINS HS 2.5 MB SPRINTER 310/312/FORD RANGER/GM BLAZER/S10 W/O OIL SEAL
70914773	FULL GASKET SET PERKINS HS 2.5 MB SPRINTER 310/312/FORD RANGER/GM BLAZER/S10 W/OIL SEAL
60934773	FULL HEAD GASKET SET PERKINS HS 2.5 MB SPRINTER 310/312/FORD RANGER/GM BLAZER/S10 W/O OIL SEAL
70934773	FULL HEAD GASKET SET HS 2.5 MB SPRINTER 310/312/FORD RANGER/GM BLAZER/S10 W/OIL SEAL
60914873	FULL GASKET SET PERKINS HS 2.8 FORD RANGER W/O OIL SEAL
70914873	FULL GASKET SET PERKINS HS 2.8 FORD RANGER W/OIL SEAL
60934873	HEAD GASKET SET PERKINS HS 2.8 FORD RANGER W/O OIL SEAL
70934873	HEAD GASKET SET PERKINS HS 2.8 FORD RANGER W/OIL SEAL

ABR N°	ORIGINAL N°	DESCRIPTION	8	8	8	8
RE02396F		VALVE STEM SEAL	8	8	8	8
RE05239F		REAR OIL SEAL		1		1
509100650		REAR MANCAL GASKET		2	2	2 2
50946877	ERR4861	REAR OIL COVER SEAL		1	1	1 1
50947267	ERR1653	DRAIN OIL GASKET		1	1	1 1
50947367	ERR1278	WATER PUMP GASKET BLOCO		1	1	1 1
50947467	ERR2018	FUEL PUMP GASKET		1	1	1 1
50947567	ERR4860	FRONT COVER GASKET BLOCO		1	1	1 1
50947667	ERR2027	VACCUM PAMP GASKET		1	1	1 1
50947767	ERR2023	INJECTION PUMP GASKET		1	1	1 1
50947867	ERR1516	INSPECTION COVER GASKET		1	1	1 1
50947967	ERR3284	WATER PUMP GASKET		1	1	1 1
50948167	ERR2026	OIL FILTER GASKET	1	1	1	1 1
50948267	ERR3490	THERMOSTATIC GASKET		1	1	1 1
50948367	ERR3283	OIL FILTER GASKET		1	1	1 1
50948467	ERR4120	BOX DISTRIBUTION GASKET		1	1	1 1
50948567		OIL RADIATOR GASKET		1	1	1 1
50962400	ERR5260	CYLINDER HEAD GASKET	1	1	1	1
50963644	70490309	VALVE COVER GASKET	1	1	1	1 1 1 1
50965300	70490307	CYLINDER HEAD GASKET				1 1 1 1
50977147	70490308	INTAKE MANIFOLD GASKET	1	1	1	1 1 1 1
80964650	70490300	OIL PAN GASKET		1	1	1 1
80966826		WASHER KIT		1	1	1 1
80967226		WASHER KIT SUP			1	1
RE05352S		FRONT OIL SEAL		1		1
RE05353S		CAMSHAFT SEAL		1		1
RE05413N		TIMMING OIL SEAL		1		1

APPLICATION



FORD RANGER TD 1995/...
FORD RANGER TD 2.8 2002/...
CHEVROLET S10 TDI/BLAZER TDI 1995/...
LAND ROVER DEFENDER 90/110/130/RANGE ROVER/DISCOVERY TDI 1994/98
MERCEDES SPRINTER TDI 1997/...
FORD RANGER TD 2.8 2002/...



50965300 Ø 92 mm

50962400 Ø 94 mm



50963644



80964650



50977147



50947567

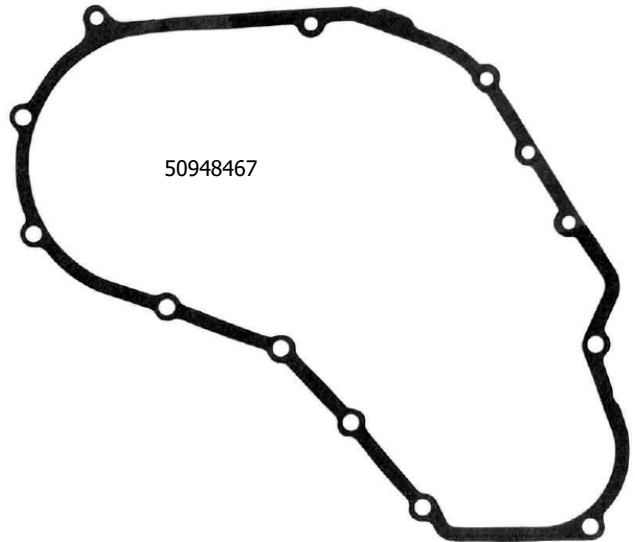

50948467



50947367



50947967



50947767/

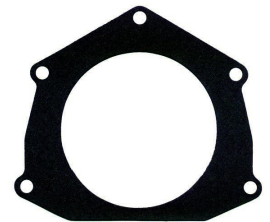

50946877



50948167

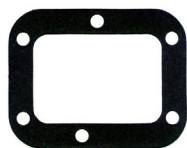

50947667



50948267



50948367



50947867



50947467



50947267



50948567



509100650



RE02396F



RE05352S



RE05239F



RE05353S



RE05413N

80966826		
Nº ABR	DESCRIPTION	Qty
50092529	WASHER KIT AL 12,0 x 18,0 x 1,5	04
50009923	mm	01
50011020	WASHER KIT CU 6,4 x 10,0 x 1,0	04
50011024	mm	04
50070329	WASHER KIT CU 7,3 x 15,2 x 1,0	07
50011228	mm	02
50022229	WASHER KIT CU 7,3 x 15,2 x 2,0	06
50021529	mm	05
50026729	WASHER KIT AL 18,5 x 22,0 x 1,5	08

80967226		
Nº ABR	DESCRIPTION	Qty
50011020	WASHER KIT CU 7,3 x 15,2 x 1,0	04
50011024	mm	04

N°SET	DESCRIPTION
60913761	FULL GASKET SET PERKINS P6354.4 ASPIRADO GM D60/70/80/90/12000/14000 W/O OIL SEAL
70913761	FULL GASKET SET PERKINS P6354.4 ASPIRADO GM D60/70/80/90/12000/14000 W/OIL SEAL
70933761	HEAD GASKET SET PERKINS P63544 ASPIRADO GM D60/70/80/90/12000/14000 W/OIL SEAL
60913763	FULL GASKET SET PERKINS P6354.4/Q20B6 TURBO GM D12000/13000 / DS12000/14000/22000 W/O OIL
70913763	FULL GASKET SET PERKINS P6354.4/Q20B6 TURBO GM D12000/13000 / DS12000/14000/22000 W/OIL
60913813	FULL GASKET SET PERKINS P6354.4 TURBO TRACTOR MF297/299 W/O OIL SEAL
70913813	FULL GASKET SET PERKINS P6354.4 TURBO TRACTOR MF297/299 W/OIL SEAL
70933763	HEAD GASKET SET PERKINS P63544/Q20B6 TURBO GM D12000/13000 / DS12000/14000/22000 W/OIL SEAL

ABR N°	ORIGINAL N°	DESCRIPTION	12	12	12	12	12
RE02590F		VALVE STEM SEAL	12	12	12	12	12
50909390	70490355	REAR COVER GASKET	1	1	1	1	1
50013349	02132	RET EIXO DA BOMBA INJETORA		1	1		1
50922198	70490352	GASKET		1	1	1	1
50922298	36814124	INSPECTION COVER GASKET		1	1	1	1
50922898	36861745	THERMOSTATIC GASKET	1	1	1	1	1
50924190	70490363	INJECTION PUMP GASKET		1	1	1	1
50924280	36831122	OIL PUMP GASKET		1	1	1	1
50924412	70490414	GASKET SET		1	1	1	1
50925570	36865532	OIL PUMP GASKET		1	1	1	1
50925698	70490378	ACTUATOR TACHIMETER GASKET		1	1	1	1
50931498	36867162	WATER PUMP GASKET	1		1	1	1
50931757	36862507	ACTUATOR TACHIMETER GASKET		1	1	1	1
50931850	36826107	INSPECTION COVER GASKET		1	1	1	1
50932453	70490177	OIL PAN GASKET			1	1	1
50932490	70490371	OIL PAN GASKET			1	1	1
50932831	36862191	INTAKE EXHAUST MANIFOLD GASKET	2	2	2	2	2
50934098	70490346	OIL PUMP TUBE GASKET		1	1	1	1
50934198	70490347	REAR OIL SEAL		1	1	1	1
50934616	70490373	OUTLET EXHASUT GASKET	1	1	1	1	1
50937298	70490725	WATER PUMP GASKET		1	1	1	1
50937798	70490725	AIR FILTER GASKET	1	1	1	1	1
50938030	70490374	INTAKE MANIFOLD GASKET	2	2	2	2	2
50938170	70490160	EXHAUST GASKET		1	1	1	1
50940598	70490198	OIL NOZZLE GASKET	3	3	3	3	3
50941055	70490265	VALVE COVER GASKET		1	1	1	1
50942198	70490154	FUEL PUMP GASKET		1	1	1	1
50943398	36856102	OIL FILTER GASKET		1	1	1	1
50944532	70490335	INTAKE EXHAUST MANIFOLD GASKET	1	1	1	1	1
50945431	36866746	INTAKE MANIFOLD GASKET	2	2	2	2	2
50945598	70490161	OIL FILTER GASKET		1	1	1	1
50945772	36866105	INJECTION PUMP GASKET		1	1	1	1
50945898	36822118	COMPRESSOR GASKET		1	1	1	1
50945998	36822118	GASKET		1	1	1	1
50950716	36831127	OIL PAN GASKET		1	1		
50954498	70490405	OIL NOZZEL JOIN	1	1	1	1	1
50954598	36833144	GASKET		1	1	1	2
50954698	36833148	THERMOSTATIC GASKET	1	1	1	1	1
50954798	70490330	OIL FILTER GASKET	1	1	1	1	1
50954898	36861448	OUTLET WATER GASKET		1	1	1	1
50958398	70490321	OIL FILTER GASKET		1	1		
50958698	36866207	WATER PUMP GASKET		1	1	1	1
50958698	70490410	WATER PUMP GASKET		1	1		
50960096		OUTLET WATER GASKET		1	1		
50971600	70490238	CYLINDER HEAD GASKET	1	1	1	1	1
50976598	36814202	OIL FILTER GASKET		1	1		
80963731	36866749	TURBOCHARGING SET	1	1	1	1	
80977840		WASHER KIT BRR		1	1	1	1
RE01050S		PULLEY OIL SEAL		1			1
RE01972S		REAR OIL SEAL	1	1			1

APPLICATION



PERKINS P6354/P6354.4 6 CIL.5.8L VEICULAR/AGRÍCOLA
CHRYSLER TRUCK DODGE D700/750/900 1970/81
MASSEY FERGUSON TRACTOR MF 296 1976/89
PERKINS P6354.4/Q20B 6 CIL.5.8L TURBO VEICULAR/AGRÍCOLA
CHEVROLET TRUCK DS12000/14000 1992/96
MASSEY FERGUSON TRACTOR MF 500B 1982/87
PERKINS P6354.4 6 CIL.5.8L TURBO
MASSEY FERGUSON TRACTOR MF 297 1989/92 MF 299 1989/9

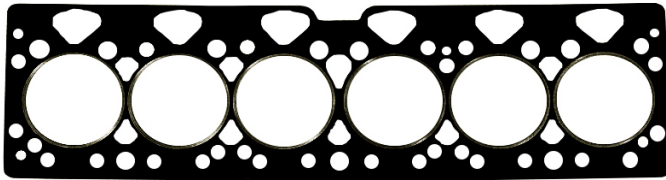

50971600



50941055



50945431



50934616

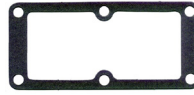

50909390



RE02590F

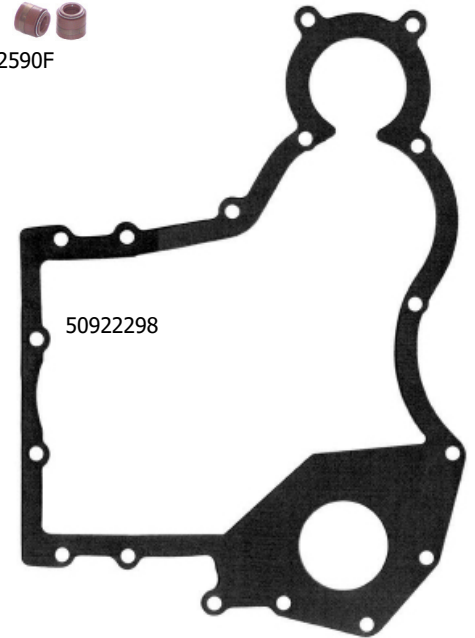

50922298



50938030



50945998

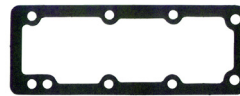

50954698



5093283



50954598



50922898



50944532



50925698



50931757

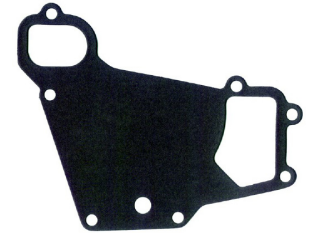

50958698

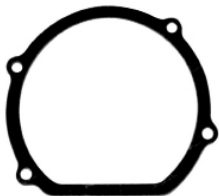

50960096



50922198

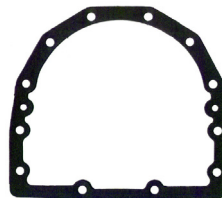

50934198



50924280



50931850



50938170



50937798

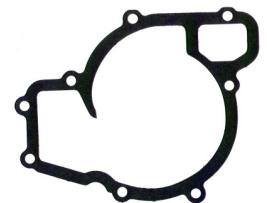

50931498



50945898



50954798



50945772



50954898



50940598



50942198



50937298

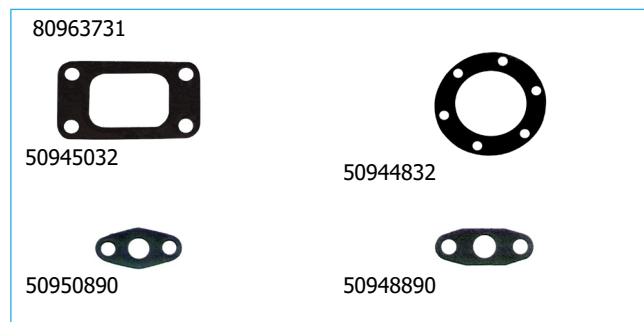
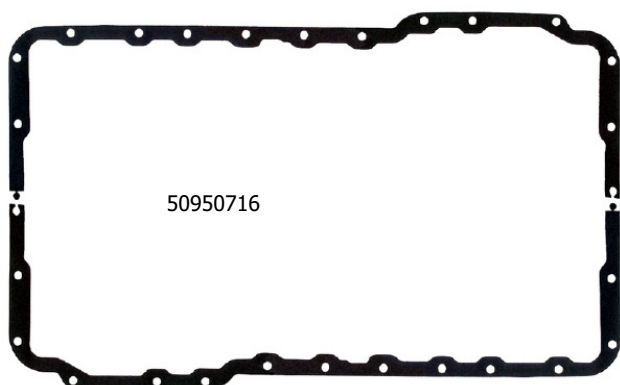
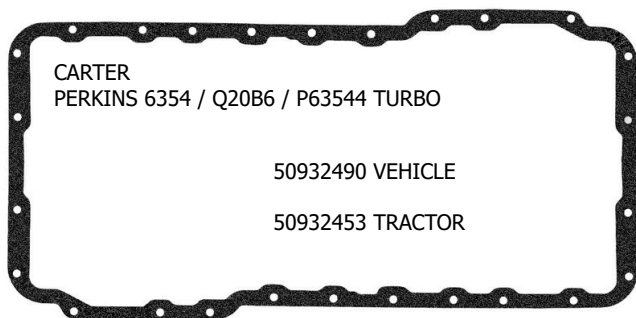

80977840			
Nº ABR	Nº Original	DESCRIPTION	Qtd
50937620	70920081	WASHER KIT Bico Inj	06
50967840	70730046	10,0x19,2x2,0mm	06
50972641	32811408	Vedador Porta Injetor	04
50963941	33811113	Vedador Placa Intermediaria	01
50964041	33817132	Anel Tubo Lubrificante Cabeçote	04
50927541	2415813	Vedador Tampa Válvulas	01



N°SET	DESCRIPTION		
60912881	FULL GASKET SET PERKINS P6357 (Veicular / Agrícola) W/O OIL SEAL		1
70912881	FULL GASKET SET PERKINS P6357 (Veicular / Agrícola) W/OIL		2
70932881	HEAD GASKET SET PERKINS P6357 (Veicular / Agrícola) W/O OIL SEAL		3

ABR N°	ORIGINAL N°	DESCRIPTION	
RE00586S		PULLEY OIL SEAL	1
50906217	70490020	EXHAUST TUBE GASKET	1 1 1
50050567		GASKET SET DE BANCADA	2 2
50906190	70490340	ACTUATOR TACHIMETER GASKE	1 1
50907390	70490349	OIL SEAL COVER GASKET	1 1
50907498	70490350	TUBE OUTLET OIL PUMP GASKET	1 1
50907850	70490201	WATER COVER GASKET	2 2
50907998	70490288	BLOCK NOZZLE GASKET	1 1
50908390	70490351	REAR COVER GASKET	1 1 1
50908498	70490723	INTAKE MANIFOLD GASKET	1 1 1
50908716	70490123	INTAKE MANIFOLD GASKET	1 1 1
50909616	70490358	INTAKE EXHAUST MANIFOLD GASKET	3 3 3
50909798	70490745	THERMOSTATIC GASKET	1 1 1
50909855	70490139	VALVE COVER GASKET	1 1 1
509105067	70409393	OIL PAN GASKET	1 1 1
50910998	70490336	WATER PUMP GASKET	1 1
50914198	70490381	FUEL PUMP GASKET	1 1
50915401	70490743	CYLINDER HEAD GASKET	1 1 1
50915698	70490049	OIL PUMP GASKET	2 2
50915798	70490392	WATER PUMP GASKET	1 1
50915953	70490132	OIL PAN GASKET	1 1
50916098	70490063	OIL PUMP GASKET	1 1
50916152	70490065	INSPECTION COVER GASKET DISTRIBUIÇÃO	2 2
50916298	70490071	OUTLET WATER CONECTION GASKET	1 1 1
50916398	70490073	FRONT CONNECTION GASKET SAÍDA ÁGUA	1 1 1
50916796	70490395	INTAKE MANIFOLD GASKET	1 1 1
50916898	70490092	INSPECTION COVER GASKET	1 1 1
50918998	70490136	FUEL PUMP GASKET	1 1
50919098	70490397	FUEL PUMP GASKET	1 1
50924412	70490414	OUTLET EXHAUST GASKET	1 1
50927098	70490304	INSPECTION COVER GASKET	1 1
50930998	70490091	OIL PUMP NOZZLE GASKET	1 1
50931698	70490143	OIL FILTER GASKET	2 2

APPLICATION



PERKINS P6357/P6357.2 6 CIL.5.8L VEICULAR/AGRÍCOLA

FORD TRUCK F11000/F12000/F13000 1981/81

M.FERGUSON TRACTOR MF 3366 1971/74 ; MF 400 1976/84 ; MF 500B 1974/82 ; MF 95X 1973/85

CHRYSLER TRUCK DODGE D700/750/900 1975/81

CHEVROLET TRUCK D60 1965/85 ; D79/75 1970/85

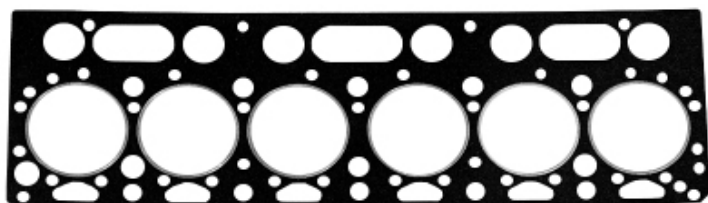

50915401

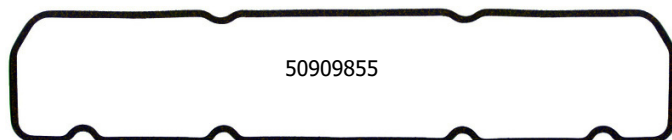

50909855

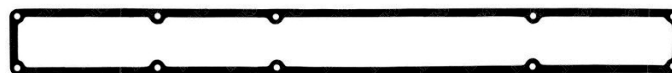

50916796



50908716

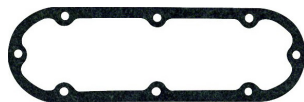

50907850



50906217

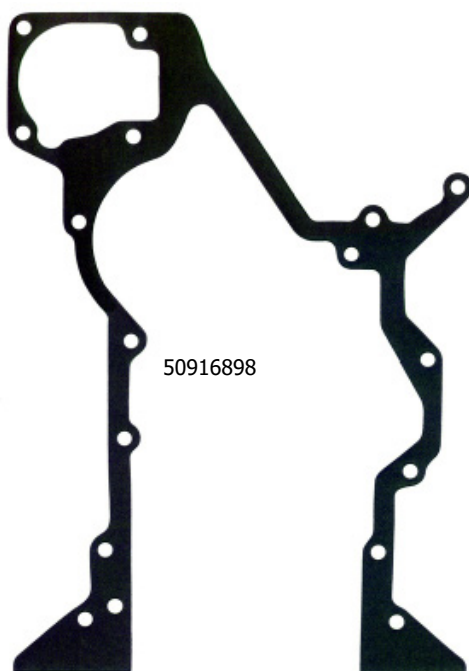

50916898



50916152



50909616



50908498



50909798



50930998



50916098



50916298



50931698



50915698

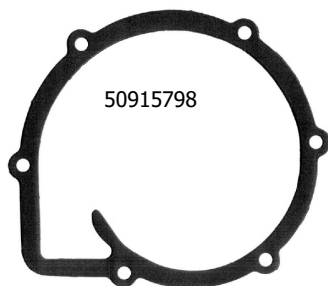

50915798



50910998



50907498



50916398



50906190



50918998

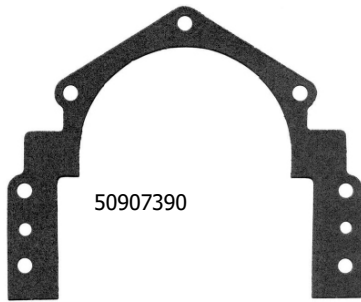

50907390

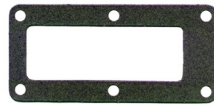

50908390

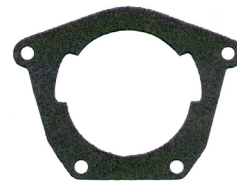

50927098



50914198



50919095



50907998



509105067



RE00586S

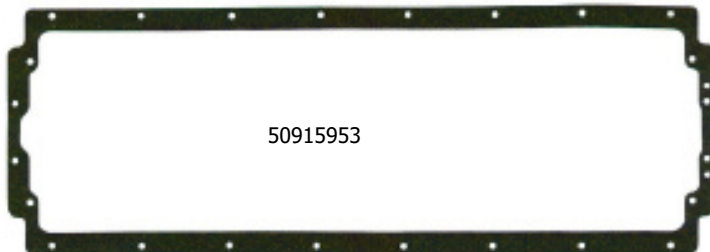

50915953



50050567



50924412

80956190		
Nº ABR	DESCRIPTION	Qty
50022224	WASHER KIT 14,0 x 20,8 x 1,5 mm	06
50035623	WASHER KIT CU 40,3 x 46,7 x 1,0	06
50945641	mm	12

N°SET	DESCRIPTION			
60913439	FULL GASKET SET PERKINS P6358 (Veicular / Agrícola) W/O OIL SEAL			1
70913439	FULL GASKET SET PERKINS P6358 (Veicular / Agrícola) W/OIL SEAL			2
70933431	HEAD GASKET SET PERKINS P6358 W/OIL SEAL			3
60933431	HEAD GASKET SET PERKINS P6358 W/O OIL SEAL			4

ABR N°	ORIGINAL N°	DESCRIPTION		
RE02590F		VALVE STEM SEAL	12	12
50905650	70490096	VALVE COVER GASKET	1	1 1 1
50906190	70490340	ACTUATOR TACHIMETER GASKET		1 1
50906217	70490020	OUTLET EXHAUST GASKET		1 1
50906716	70490106	INTAKE EXHAUST MANIFOLD GASKET	1	1 1 1
50907498	70490350	OUTLET OIL PUMP GASKET		1 1
50907850	70490101	WATER COVER GASKET		2 2
50907998	70490288	BLOCK NOZZLE GASKET		1 1
50908498	70490421	INTAKE MANIFOLD GASKET	1	1 1 1
50908716	70490400	OUTLET INTAKE EXHAUST GASKET	1	1 1 1
509104967	70490393	OIL PAN GASKET		1 1
50910998	70490734	WATER PUMP GASKET		1 1
50914198	70490381	FUEL PUMP GASKET		1 1
50915698	70490049	OIL PUMP GASKET		1 1
50915798	70490392	WATER PUMP GASKET		1 1
50915953	70490132	OIL PAN GASKET		1 1
50916098	70490063	OIL PUMP GASKET		1 1
50916152	70490065	INSPECTION COVER GASKET DISTRIBUIÇÃO		2 2
50917098	704490097	INSPECTION COVER GASKET		1 1
50917116	70490107	INTAKE SIDE EXHAUST GASKET	2	2 2 2
50917398	70490114	REAR COVER GASKET	1	1 1 1
50917598	70490128	TIMING COVER GASKET		1 1
50918995	70490112	FUEL PUMP GASKET		1 1
50919098	70490397	FUEL PUMP GASKET		1 1
50924412	70490414	OUTLET EXHAUST GASKET	1	1 1 1
50926950	70490026	ACTUATOR TACHIMETER GASKET		1 1
50927098	70490394	INSPECTION COVER GASKET		1 1
50927198	70490069	EXHAUST TUBE GASKET		1 1
50930409	70490196	CYLINDER HEAD GASKET	1	1 1 1
50930590	70490809	WATER COVER GASKET		2 2 2
50930690	70490117	INTAKE MANIFOLD GASKET		2 2 2
50930790	70490201	INTAKE MANIFOLD GASKET		2 2 2
50930890	70490119	THERMOSTATIC GASKET	1	1 1 1
50930998	70490091	OIL PUMP NOZZLE GASKET		1 1
50931698	70490143	OIL FILTER GASKET		1 1
50934598	70490116	REAR COVER GASKET	1	1 1 1
50959967	70490153	INTAKE EXHAUST MANIFOLD GASKET	4	4 4 4
80978126		WASHER KIT	1	1 1 1
RE01050S		PULLEY OIL SEAL		1
RE01972S		REAR OIL SEAL		1

APPLICATION

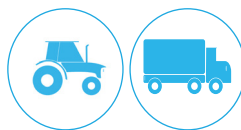

PERKINS P6358 6 CIL.5.8L VEICULAR/AGRÍCOLA
 FORD TRUCK F11000/F12000/F13000 1982/92
 M.FERGUSON TRACTOR MF 295 1976/89 MF 400C 1971/74
 CHEVROLET TRUCK D11000/D13000/19000/21000/22000 1985/91 D12000 1991/96

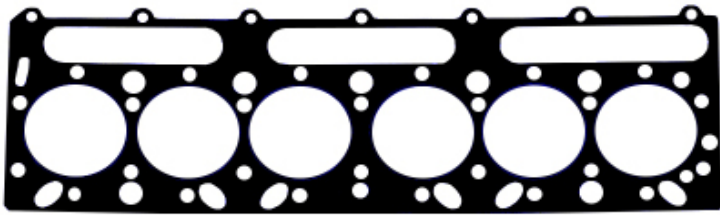

50930409



50905650



50906217



50930690

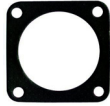

50908716



50906716



50930790



50917116



50959967



50915798

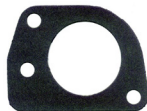

50930890



50908498



50934598



50910998

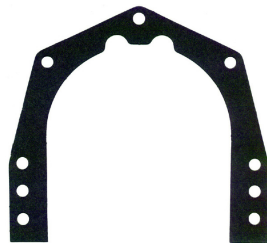

50917598



50916152



50916098



50918998



50917098



50927098

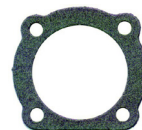

50906190



50918995



50907998



50919095



50914198



50930590

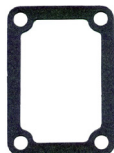

50917390



50907850



509104967



50926950

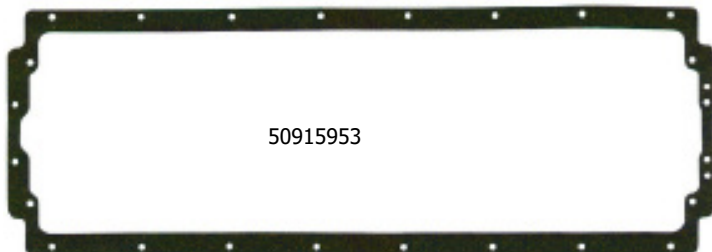

50915953

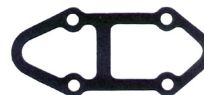

50927198



50931698



50907498



50930998



50915698



RE01050S



RE01972S



RE02590F



50924412

80978126		
Nº ABR	DESCRIPTION	Qty
50011228	WASHER KIT AL 8,0 x 12,0 x 1,0	13
50019725	mm	12
50014029	WASHER KIT AL 13,2 x 17,1 x 2,0	12
50014024	mm	6
50937620	WASHER KIT AL 10,0 x 14,1 x 1,5	6